

PLEASE CHECK WWW.MOLEX.COM FOR LATEST PART INFORMATION

Part Number: [0906631261](#)
Status: **Active**
Description: 2.54mm (.100") Pitch QF-50™ Vertical, MIL Keying with Latch/Eject Levers, Shrouded Header, 26 Circuits

Documents:

[3D Model](#) [Product Specification PS-99020-0015 \(PDF\)](#)
[Drawing \(PDF\)](#) [RoHS Certificate of Compliance \(PDF\)](#)

Agency Certification

CSA LR19980
 UL E29179

General

Product Family Ribbon Cable / Wire Trap Connectors
 Series [90663](#)
 Comments Eject Levers
 Component Type PCB Header
 Glow-Wire Compliant No
 Product Name QF-50™

Physical

Circuits (Loaded) 26
 Color - Resin Black
 Durability (mating cycles max) 300
 Entry Angle Vertical
 Flammability 94V-0
 Lock to Mating Part None
 Material - Metal Brass
 Material - Plating Mating Gold
 Material - Plating Termination Tin
 Material - Resin Polyester
 Number of Rows 2
 PCB Retention None
 PCB Thickness Recommended (in) 0.062 In
 PCB Thickness Recommended (mm) 1.60 mm
 Packaging Type Tray
 Pitch - Mating Interface (in) 0.100 In
 Pitch - Mating Interface (mm) 2.54 mm
 Plating min: Mating (µin) 4
 Plating min: Mating (µm) 0.1
 Plating min: Termination (µin) 118
 Plating min: Termination (µm) 3
 Polarized to PCB No
 Shrouded Fully
 Stackable No
 Surface Mount Compatible (SMC) No
 Temperature Range - Operating -25°C to +85°C
 Termination Interface: Style Through Hole
 Wire Insulation Diameter N/A
 Wire Size AWG N/A
 Wire/Cable Type Ribbon Cable

Electrical

Current - Maximum per Contact 2.5A
 Voltage - Maximum 250V AC/DC

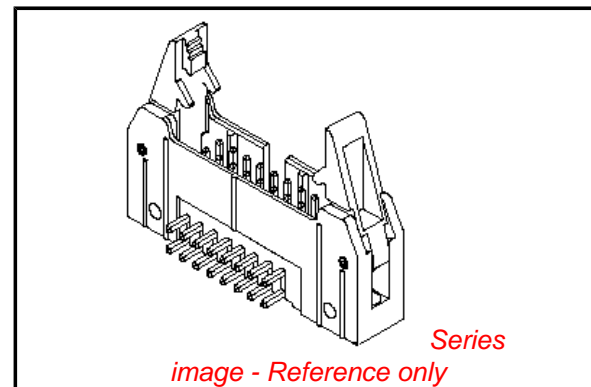

EU RoHS

ELV and RoHS
Compliant
REACH SVHC
 Not Reviewed
Halogen-Free
Status
Not Reviewed

China RoHS



Need more information on product environmental compliance?

Email productcompliance@molex.com
 For a multiple part number RoHS Certificate of Compliance, [click here](#)

Please visit the [Contact Us](#) section for any non-product compliance questions.

Search Parts in this Series

[90663Series](#)

Mates With

[90635](#)

Solder Process Data

Lead-free Process Capability

Wave Capable (TH only)

Material Info**Reference - Drawing Numbers**

Product Specification

PS-99020-0015

Sales Drawing

SDA-90663E

This document was generated on 03/16/2010

PLEASE CHECK WWW.MOLEX.COM FOR LATEST PART INFORMATION

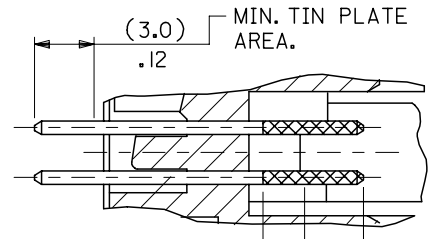
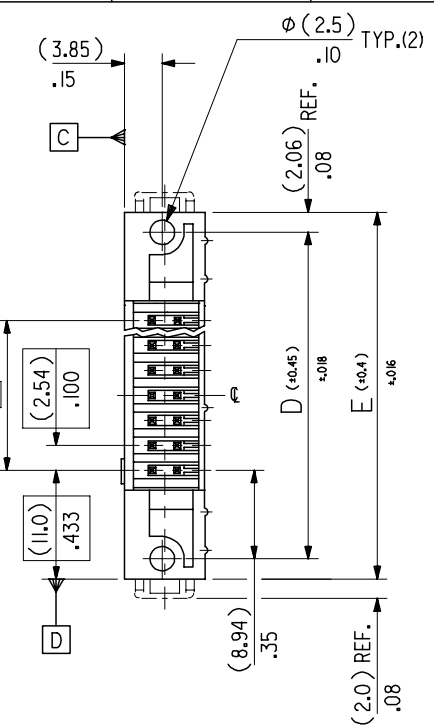
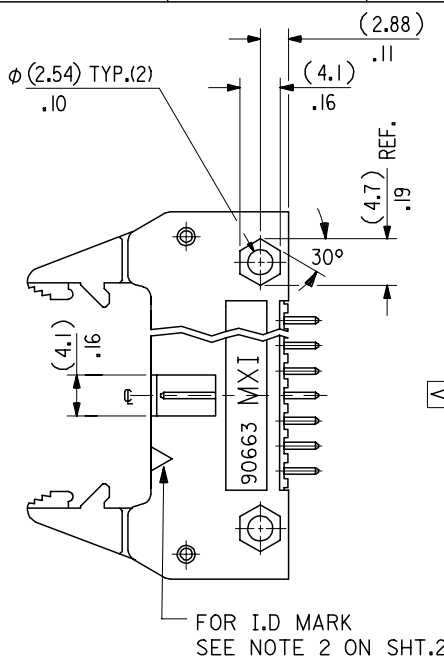
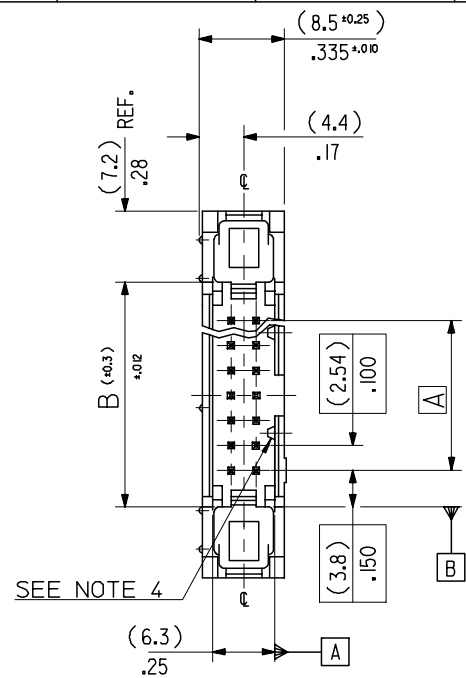
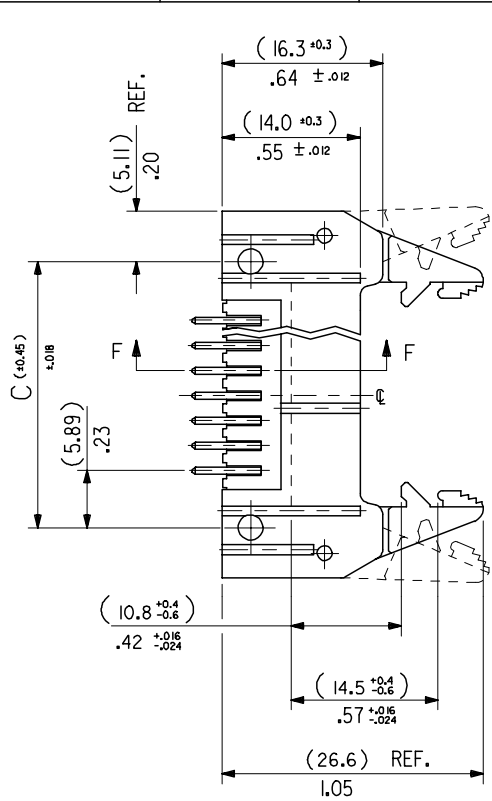

- NOTES:**
- FOR MATERIAL SPECIFICATION SEE NOTE 1. ON SHEET 2.
 - FOR RECOMMENDED P.C.B. HOLE PATTERN, PART No's AND UNSTATED DIMENSIONS SEE SHEET 2.
 - PRODUCT SPEC.No.: PS-99020-0015.
 - THIS RIB IS NOT PRESENT ON 10 & 14 CKT PARTS.

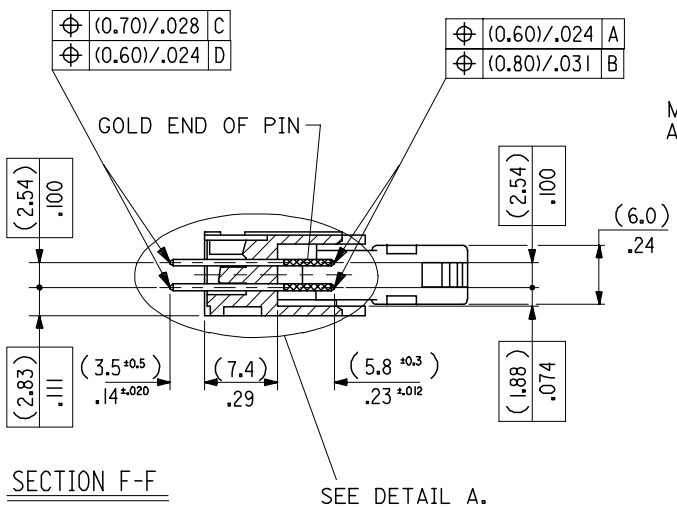

DIMENSIONS FOR SELECTIVE PLATING'S, SCALE 4:1

ADDED SHT 9 EC NO: E2007-0243 DRWN: DNASZKI, EMI CZ 2007/01/10 CHKD: J. DENNEHY 2007/01/22 APPR: DENNEHY 2007/01/23	QUALITY SYMBOLS ▽=0 ▽=0	GENERAL TOLERANCES (UNLESS SPECIFIED)		DIMENSION STYLE MM/IN	SCALE 2:1	DESIGN UNITS METRIC	THIRD ANGLE PROJECTION
		4 PLACES ± --- ± --- 3 PLACES ± --- ±.008 2 PLACES ± 0.20 ±.008 1 PLACE ± 0.20 ± --- ANGULAR ± 2 °	DRAWN BY POB CHECKED BY JDENNEHY APPROVED BY JDENNEHY MATERIAL NO.	DATE 1990/08/03 DATE 2004/11/24 DATE 2004/11/24	TITLE QF50 SRD HDR VT W/ELV	MOLEX INCORPORATED	DOCUMENT NO. SDA-90663E
DRAFT WHERE APPLICABLE MUST REMAIN WITHIN DIMENSIONS		SEE SHEET 2		THIS DRAWING CONTAINS INFORMATION THAT IS PROPRIETARY TO MOLEX INCORPORATED AND SHOULD NOT BE USED WITHOUT WRITTEN PERMISSION			

(78.74)/3.100	(86.34)/3.400	(90.52)/3.564	(96.62)/3.804	(100.74)/3.966	90663-1641	90663-1642	90663-1643		64
(73.66)/2.900	(81.26)/3.200	(85.44)/3.364	(91.54)/3.604	(95.66)/3.766	↑ -1601	↑ -1602	↑ -1603		60
(60.96)/2.400	(68.56)/2.700	(72.74)/2.864	(78.84)/3.104	(82.96)/3.266	↑ -1501	↑ -1502	↑ -1503	90663-1509	50
(48.26)/1.900	(55.86)/2.200	(60.04)/2.364	(66.14)/2.604	(70.26)/2.766	↑ -1401	↑ -1402	↑ -1403	↑ -1409	40
(40.64)/1.600	(48.24)/1.900	(52.42)/2.064	(58.52)/2.304	(62.64)/2.466	↑ -1341	↑ -1342	↑ -1343	↑ -1349	34
(35.56)/1.400	(43.16)/1.700	(47.34)/1.864	(53.44)/2.104	(57.56)/2.266	↑ -1301	↑ -1302	↑ -1303	↑ -1309	30
(30.48)/1.200	(38.08)/1.500	(42.26)/1.664	(48.36)/1.904	(52.48)/2.066	↑ -1261	↑ -1262	↑ -1263	↑ -1269	26
(22.86)/.900	(30.46)/1.200	(34.64)/1.364	(40.74)/1.604	(44.86)/1.766	↑ -1201	↑ -1202	↑ -1203	↑ -1209	20
(17.78)/.700	(25.38)/1.000	(29.56)/1.164	(35.66)/1.404	(39.78)/1.566	↑ -1161	↑ -1162	↑ -1163	↑ -1169	16
(15.24)/.600	(22.84)/.900	(27.02)/1.064	(33.12)/1.304	(37.24)/1.466	↑ -1141	↑ -1142	↑ -1143	↑ -1149	14
(10.16)/.400	(17.76)/.700	(21.94)/.864	(28.04)/1.104	(32.16)/1.266	↓ 90663-1101	↓ 90663-1102	↓ 90663-1103	↓ 90663-1109	10
A	B	C	D	E	ENG. NO. GS1 PLATING	ENG. NO. GS2 PLATING	ENG. NO. GS3 PLATING	ENG. NO. PRE TIN	NO. OF CKTS.

NOTES

1.MATERIAL

HEADER : GLASS FILLED POLYESTER (UL 94V0), COLOUR - BLACK.
 PINS : BRASS SIZE □ (0.635)/.025 .
 LEVER : GLASS FILLED POLYESTER (UL 94V0), COLOUR - BLACK.

2.COLOUR IDENTIFICATION MARK FOR PLATING OPTIONS.

90663-1**1, (1um)/.039uin MIN. NICKEL UNDERPLATE. CONTACT AREA
 GS1 PLATING (0.1um)/.004uin MIN. GOLD. SOLDER AREA (3um)/.118uin MIN.
 TIN. COLOUR MARK: YELLOW.
 90663-1**2, (1um)/.039uin MIN. NICKEL UNDERPLATE. CONTACT AREA
 GS2 PLATING (0.76um)/.030uin MIN. GOLD. SOLDER AREA (3um)/.118uin MIN.
 TIN. COLOUR MARK: BROWN.
 90663-1**3, (1um)/.039uin MIN. NICKEL UNDERPLATE. CONTACT AREA
 GS3 PLATING (0.25um)/.010uin MIN. GOLD. SOLDER AREA (3um)/.118uin MIN.
 TIN. COLOUR MARK: BLUE.
 90663-1**9, (0.5-1um)/.020-.040uin NICKEL UNDER (1.0-3.0um)/.039-.118uin TIN.
 PRE-TIN COLOUR MARK: BLACK, (NO MARK).

3. RECOMMENDED PCB THICKNESS 1.6mm

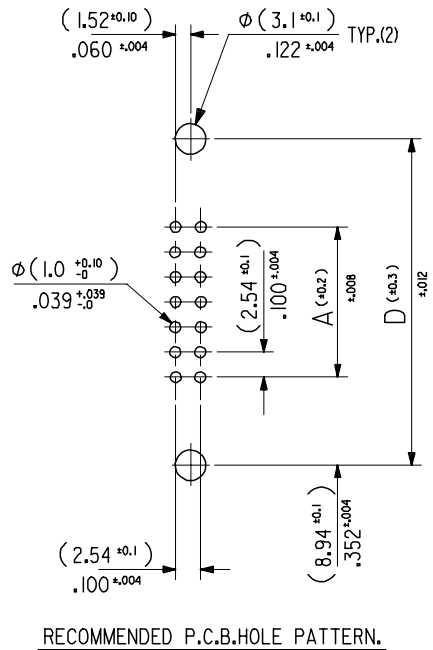

RECOMMENDED P.C.B.HOLE PATTERN.

ADDED NOTE 3 EC NO: E2008-0129 DRWN: OBYRNES 2007/09/13 CHKD: 2007/09/13 APPR: EOMAHONY 2007/09/14	QUALITY SYMBOLS ▽=0 ▽=0	GENERAL TOLERANCES (UNLESS SPECIFIED)	DIMENSION STYLE MM/IN	SCALE 2:1	DESIGN UNITS METRIC	THIRD ANGLE PROJECTION
		4 PLACES ± --- ± --- 3 PLACES ± --- ± .008 2 PLACES ± 0.20 ± .008 1 PLACE ± 0.20 ± --- ANGULAR ± 2 °	DRAWN BY POB CHECKED BY JDENNEHY APPROVED BY JDENNEHY MATERIAL NO.	DATE 1990/08/03 DATE 2004/11/24 DATE 2004/11/24	TITLE QF50 SRD HDR VT W/ELV	MOLEX INCORPORATED
DRAFT WHERE APPLICABLE MUST REMAIN WITHIN DIMENSIONS		SEE CHART	DOCUMENT NO. SDA-90663E	THIS DRAWING CONTAINS INFORMATION THAT IS PROPRIETARY TO MOLEX INCORPORATED AND SHOULD NOT BE USED WITHOUT WRITTEN PERMISSION		